

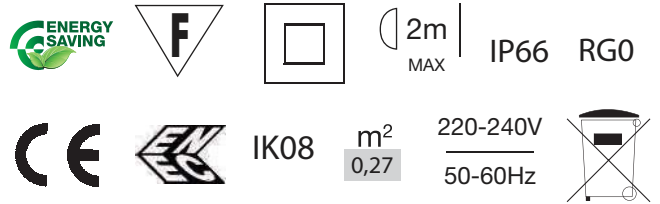

FASTLED 3 PR



FASTLED 3 PR

CORPO: Corpo in lega d'alluminio pressofuso verniciato con polveri poliesteri, colore standard grigio canna di fucile.

SCHERMO: Vetro temperato di chiusura piano sp. 4mm.

GUARNIZIONI: In silicone.

UNITÀ DI ALIMENTAZIONE: Componenti elettrici montati all'interno del corpo dell'apparecchio nell'apposito vano. Vita presunta degli alimentatori a Tc fino a 100.000h per soluzione dimmerabile.

Alimentazione 220÷240V/50-60Hz cos φ 0.95.

Classe di isolamento II, a richiesta disponibile cl. I.

CONNESSIONE: Pressacavo in ottone M20 IP68 adatto per cavo 9÷11 mm. Morsettiera di alimentazione a innesto rapido 1.0÷2.5 mmq.

PROTEZIONE EXTRATENSIONI: Gli apparecchi standard sono equipaggiati con TMOV che garantisce una resistenza alle sovratensioni di modo differenziale fino a 10kV e in modo comune fino a 6kV. Per classe I, disponibile a richiesta con SPD con grade di immunità maggiorato (10kV/10kA).

FISSAGGIO: Staffa di fissaggio con goniometro di regolazione dell'inclinazione con step di 5°.

BODY: Made of die-cast aluminium painted with polyester powders, standard colour dark grey.

SCREEN: Tempered flat glass, thickness 4mm.

GASKETS: Made in silicone.

SUPPLY UNIT: Electrical components mounted inside the body, in the specific compartment.

Life expectancy of the ballasts at Tc 100.000h for dimmable solution.

Supply voltage 220÷240V/50-60Hz cos φ 0.95.

Insulation class II, class I available on request.

CONNECTION: M20 IP68 suitable brass cable gland for 9÷11 mm cable. Plug-in power supply terminal block rapid 1.0÷2.5 mmq.

OVERVOLTAGE PROTECTION: Standard fitting are equipped with TMOV which guarantees a resistance to overvoltages in different ways up to 10kV and in common mode up to 6kV. For class I, available on request with SPD with increased immunity grade (10kV/10kA).

FIXING: Bracket with goniometer for tilt adjustment with 5° steps.

DIMENSIONI - DIMENSIONS

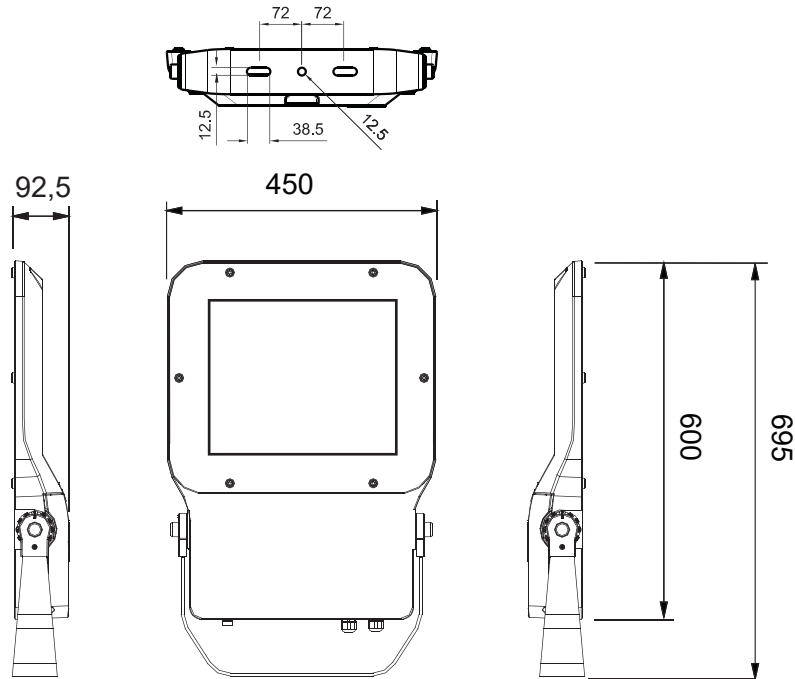

MODULI LED: Moduli led costituiti da 48 o 100 chips di ultima generazione. Tecnologia multi-die che garantisce un elevatissimo flusso e una ottima efficienza 170lm/W @ 640mA 25°C. Vita utile 100.000h L90B10 (TM-21 Projection). Ottica secondaria in PMMA stabilizzato. Concetto di illuminazione Multi-layer in cui ogni ottica illumina tutta la sede stradale in modo da garantire i parametri di uniformità anche in caso di spegnimento di qualche LED. Disponibili diverse fotometrie per ottimizzare le prestazioni nei vari ambiti.

LED MODULES: LED modules consisting of 48 or 100 LED chip of last generation. Multi-die technology that guarantees a very high flow and an excellent efficiency 170lm/W @ 640mA 25°C. Expected life of the led 100.000h L90B10 (TM-21 Projection). Secondary optic in stabilized PMMA. Multi-layer lighting concept in witch each optic illuminates the entire street so as to guarentee uniformity parameters even if some LEDs are failed. Available different photometric curves to optimized the performances in various areas.

Staffa di fissaggio in acciaio verniciato
Mounting bracket in painted steel



Dissipatore integrato nel corpo
Heatsink integrated into the body

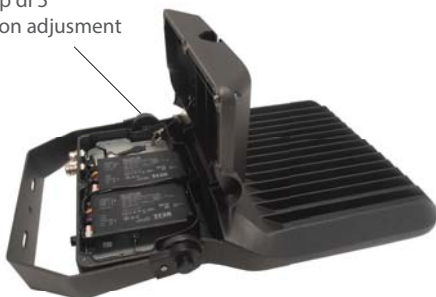

Goniometro per la regolazione dell'inclinazione con step di 5°
Goniometer for inclination adjusment with 5° step

Vetro piano temperato
Tempered flat glass



▲DATI IDENTIFICATIVI E PRESTAZIONI - IDENTIFICATION DATA AND PERFORMANCES

Codice iniziale Initial code	Nome Name	Watt	mA max	N. Led	Lm out	Kelvin	CRI	IP	CL	Col	Weight	App.
004914843_	FASTLED 3 PR E 48LED 200 3K	200	630	48	26350	3000	75	66	II	GR CF ■	13	
004914844_	FASTLED 3 PR E 48LED 200 4K	200	630	48	27900	4000	75	66	II	GR CF ■	13	
0049110043_	FASTLED 3 PR E 100LED 400 3K	340	525	100	45850	3000	75	66	II	GR CF ■	15	
0049110044_	FASTLED 3 PR E 100LED 400 4K	340	525	100	48500	4000	75	66	II	GR CF ■	15	

Come comporre il codice prodotto (rispettare la sequenza): **Codice iniziale (▲) Codice finale (●) Dimmerazione (■)**

How to compose the product code (respect the sequence): **Initial code (▲) Last number (●) Dimming profile (■)**

PERFORMANCE - PERFORMANCES

N. LED	mA	Watt	3000K LED Lumen	3000K Lm output	4000K LED Lumen	4000K Lm output
48	350	103	17700	15750	18750	16700
	500	150	24250	21600	25650	22850
	600	200	29400	26350	31350	27900
100	200	121	21650	19250	22900	20400
	350	215	36350	32350	38450	34200
	525	340	51550	45850	54500	48500

●FOTOMETRIE - PHOTOMETRY

Codice finale Last number	Apertura fascio Lighting range
0	120°
1	90°
3	S1
4	S4
5	AS3
6	AS
7	23°
8	35°
9	60°
A	AS60

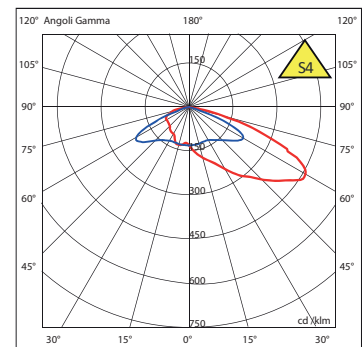
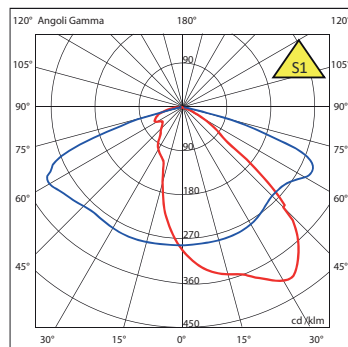
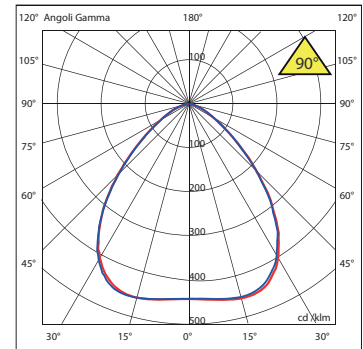
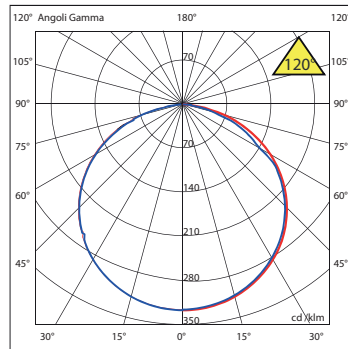

Gruppo di rischio fotoblogico secondo EN62471: ESENTE (RGO)

Photobiological risk group according to EN62471: EXEMPT (RGO)

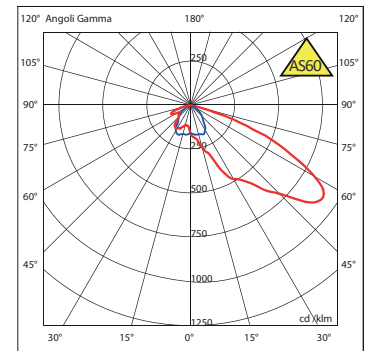
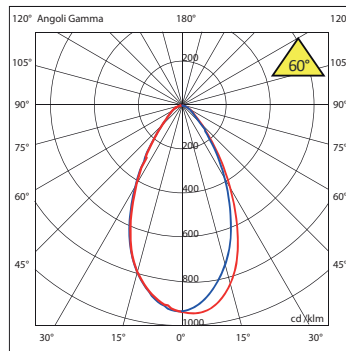
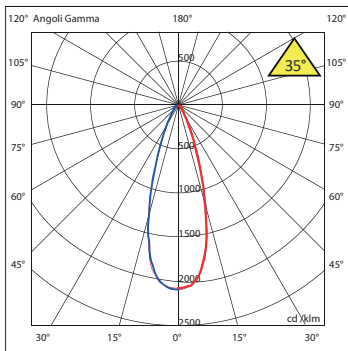
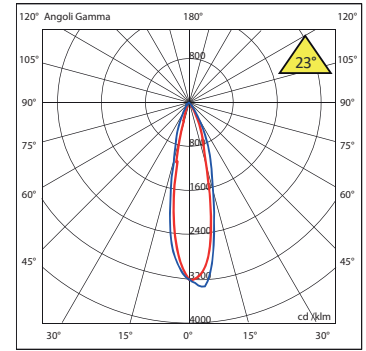
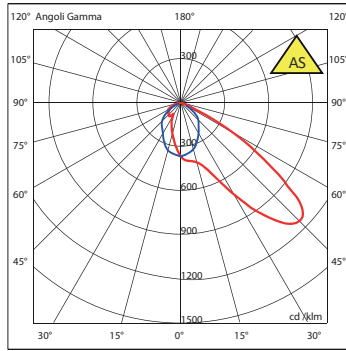
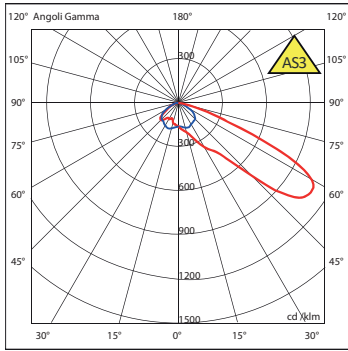

■ **DIMMERAZIONE - DIMMING**

Code	Rset	Switch	1-10V	Dali	CLO	Crono timer	Mains dim	Radio Waves	Conveyed waves
FD	S*	/	/	S	S*	S*	S*	/	/

- S Standard con possibilità di programmazione dopo l'acquisto
 - S * Standard con programmazione da eseguire in azienda
 (vedi modulo dimmer disponibile sul sito Web www.faeber.com)

- S Standard with possibility of setting after purchase
 - S* Standard with setting to be done at the factory
 (see dimming form available on website www.faeber.com)

ACCESSORIO - ACCESSORY



Cod. 000090801	BUSTA FUNE DI SICUREZZA SAFETY ROPE ENVELOPE
----------------	---

www.faeber.com

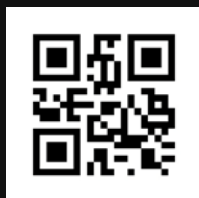

Faerber Lighting System SpA
Via Papa Giovanni XXIII - Ang. Via Padre Pio • 21040 Uboldo (VA) • Italy • Tel. +39.0296787811 • Fax +39.0296788846 • info@faeber.com